

Capacitive, Inductive, and Hall Sensing for HMI in Automotive Applications



ABSTRACT

With vehicle electrification on the rise, there is a business need to replace electro-mechanical devices in automotive designs. Many interaction points in a vehicle require some kind of button, dial, or switch to register user input. These interaction points can be designed under a variety of new technological implementations that allow more design freedom than the traditional electro-mechanical applications. This paper will discuss different HMI applications commonly used in vehicles and the different technologies that can be used to implement these applications.

Table of Contents

1 Introduction	2
2 Push Buttons	2
2.1 Mechanical Buttons.....	2
2.2 Hall-Effect Switches.....	2
2.3 Capacitive Touch Buttons.....	3
2.4 Inductive Touch Buttons.....	4
3 Dials, Knobs, and Rotational Selectors	8
3.1 Mechanical Dials.....	8
3.2 Hall 3D Linear Dial.....	8
3.3 Encoder Using Hall.....	8
3.4 Encoder Using Inductive.....	10
3.5 Scroll Wheels.....	11
3.6 Rocker Switches.....	13
4 Summary	14
5 References	15
5.1 Device Support.....	15
5.2 Related Documentation.....	15

Trademarks

All trademarks are the property of their respective owners.

1 Introduction

Human-Machine-Interface (HMI) comes in many different forms. In a vehicle, this can be anything from a media button, to an air control knob on the center console, to a switch used to control the window. Historically these have been implemented using electro-mechanical contacts in different forms. These contacts can wear down over time as the current flows between two different pieces of metal or when the metal contacts move and rub against each other. New options in contactless sensing, however, can provide a robust solution with a longer lifetime. For push buttons, designers can replace the electro-mechanical contact with a magnet and magnetic sensor, or use an inductive or capacitive touch instead. For rotational sensing, designers can implement absolute angle detection with a magnetic Hall-effect sensor that can also calculate the angle of the magnet to make the implementation easier on the MCU. Designers can also replace encoder applications with magnetic or inductive sensing options depending on the key considerations of the design. Regardless of the application, these contactless sensing methods can bring a more robust solution that also provides some design flexibility.

2 Push Buttons

Push buttons can be found in both the center infotainment display and the steering wheel on a car. These buttons can be used for many different applications, including media controls, air conditioning, cruise control, or even as a button to detect the end user activating the car horn. Implementing these push buttons can be done with various technologies such as mechanical switches, magnetic switches, capacitive touch, or inductive touch solutions.

2.1 Mechanical Buttons

Mechanical push buttons use a metal terminal that physically moves to connect or disconnect a circuit. In some cases, a spring is used to ensure that the button returns to the normal position after a press event. The figure below shows how snap domes can create mechanical motion and electrical connection, as well.

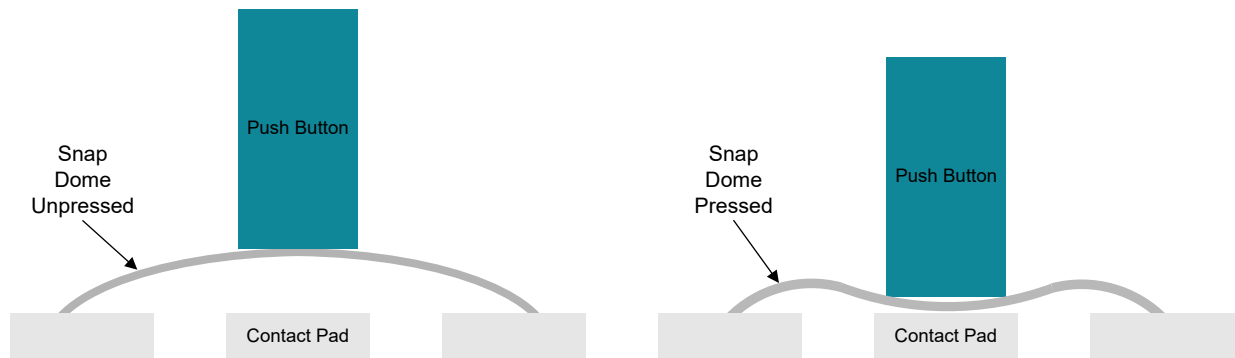

Figure 2-1. Snap Dome Stackup Example

One common problem with these mechanical solutions is wear and tear. As the mechanical contact bridges the electrical connections, the metal can wear down as the electrical connection is repeatedly connected and disconnected.

2.2 Hall-Effect Switches

Designers can replace some electro-mechanical contacts with a magnet and Hall-effect switch. The overall mechanical structure can stay the same, but the potential for wear and tear decreases when you remove the metal contacts.

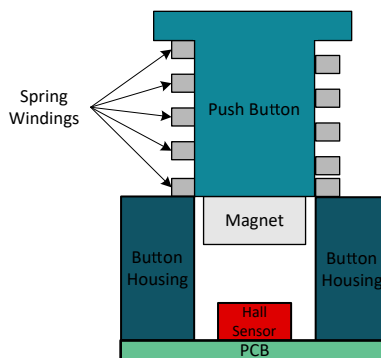

Figure 2-2. Hall-Effect Push Button Stackup Example

Hall-effect sensors work by sensing the strength of the magnetic field and Hall based switches provide a digital output when the magnetic field strength is over a specified threshold. Similar to Hall switches, reed switches also provide a digital output based on the magnetic field, but reed switches still have the mechanical contact in them that can wear down over time. Hall-effect switches come in a variety of options for different thresholds and directional sensitivities to enable design diversity. Devices like the [TMAG5328](#) even have a resistor adjustable threshold that allows for easy mechanical design adjustments or swapping out the magnet used.

2.3 Capacitive Touch Buttons

Capacitive touch buttons are a common replacement for mechanical push buttons. They provide a flat touch surface that can work with a light user touch. These buttons function by using the capacitive characteristics of the human body to trigger a capacitive change when the touch button is pressed. On a fundamental level, the fringing effect of an electrode couples to the finger of the user as the finger approaches the touch surface, causing a capacitive shift that can be interpreted as a touch.

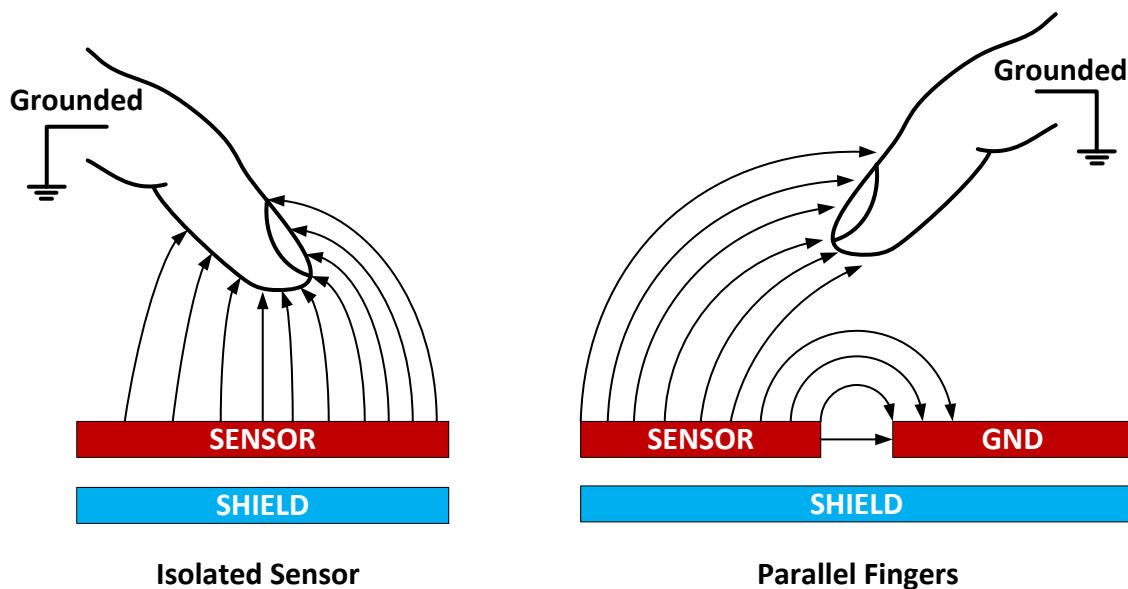

Figure 2-3. Capacitive Sensor Fringing Electric Fields for Isolated and Parallel Finger Topologies

Due to this functionality, capacitive touch buttons are a good option for a seamless HMI panel. They can also be used as proximity sensors so the user does not even have to touch the surface. One downside to these buttons is their reliance on the capacitance from the hand. If the user is wearing gloves, it can make sensing the touch event more difficult. Additionally, usage on the external surfaces of a vehicle like a door handle can mean that metal must be used for the touch surface. This changes the topology to be more of a parallel plate capacitor because the fringing effect will couple to the metal surface. In this style of implementation, the change in distance between the plates causes a capacitive change that can be used to detect a button press.

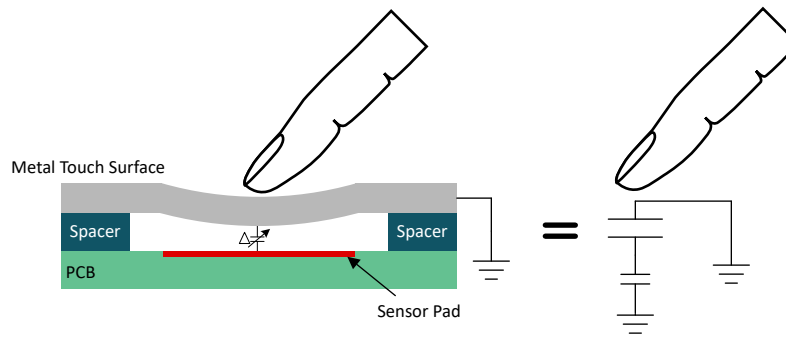

Figure 2-4. Capacitive Touch on Metal

In this type of implementation, using the capacitive sensor with gloves is easier because the metal will move either way, however this implementation may require grounding the touch surface to reduce the amount of noise in the measurement. The [Capacitive Touch Through Metal Using MSP430 MCUs with CapTIvate Technology application note](#) goes into more details on this application.

2.4 Inductive Touch Buttons

Inductive touch buttons measure the inductance shift cause by the deflection in a metal target above their sensor, which can be used in applications that require a seamless touch button that works based on a force applied to the surface.

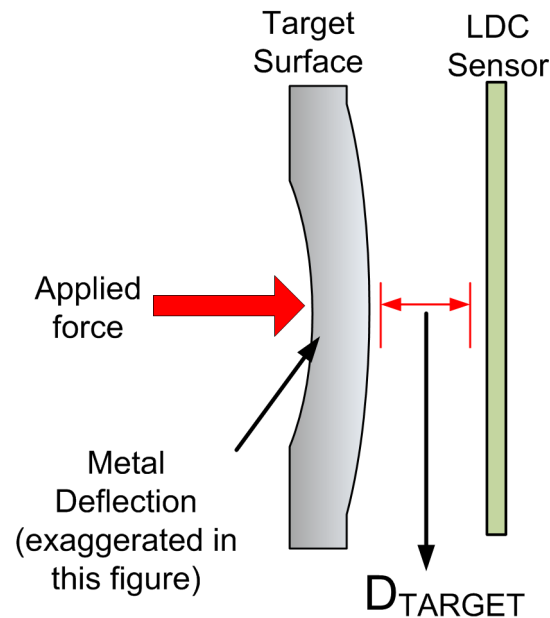

Figure 2-5. Inductive Sensing Basic Operation

Inductive sensing works based on the force applied, therefore there is no need to GND the surface like in some capacitive touch buttons, and this setup allows inductive sensing to work even when the user is wearing gloves or if moisture gets on the touch surface. Devices like the [LDC3114-Q1](#) process the change in the inductive sensor and provide a digital output that signifies a button press, relieving the MCU from any data processing of the button data. The algorithm that processes the button press also includes a baseline tracking that helps remove false detections due to dirt, damage, or environmental changes like temperature.

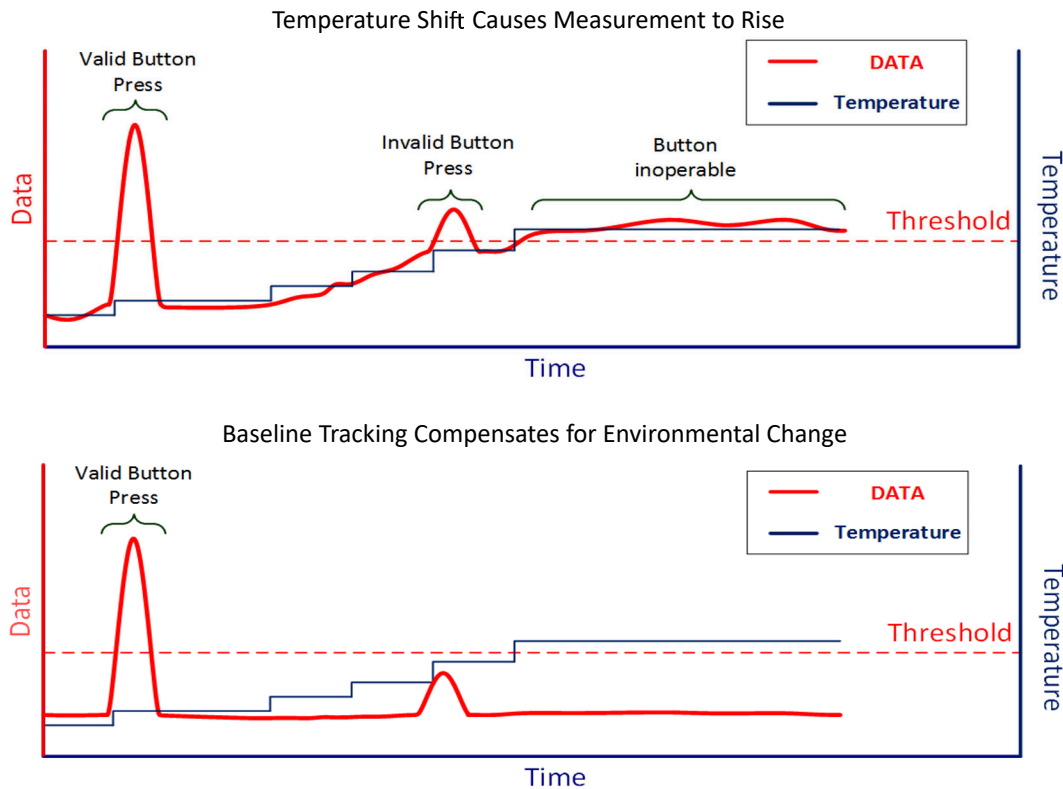

Figure 2-6. Baseline Tracking

Even though the sensor requires a metal target, it is not required to make the touch surface metal. Examples like the [TIDA-060039](#) use a plastic touch surface with metal tape underneath to act as the target.

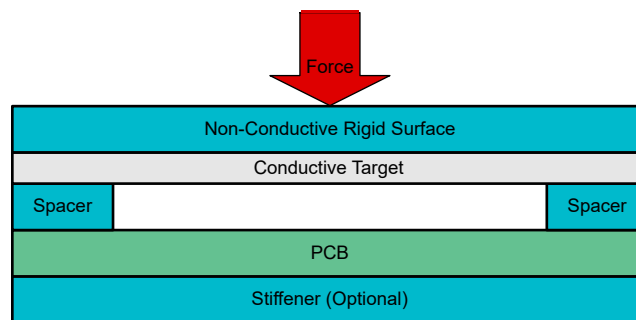

Figure 2-7. Inductive Touch Button Stackup With Non-Conductive Touch Surface

Inductive touch can use many different materials as the target and offer a robust nature for sensing, therefore these buttons can be used on both the interior and exterior of a vehicle to sense a user touch input.

Many push buttons inside a car have an illumination component to them. An inductive touch button uses a metal target, therefore extra consideration is needed for how to handle the illumination. The easiest way to show illumination with the button is to offset the light from the touch surface of the button. Having the illumination off to the side, above, or below the button separates the illumination from the touch button stackup, but that approach may not always be acceptable in the design. One way to include the light in the middle of the touch surface is to have an LED on either side of the sensor coil and use an illumination guide to allow light to disperse above the metal target like in the following stackup.

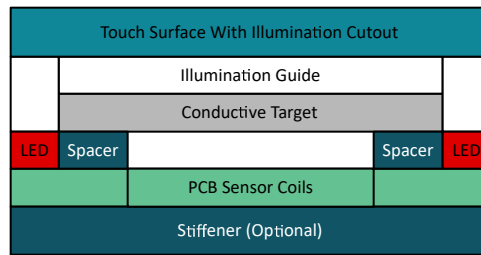

Figure 2-8. Illuminated LDC Touch Button With Illumination Guide

The desired illumination cutout can be used on the outer touch surface, and the metal target iteration with the sensor coils remains intact in this implementation. However, this design requires a thin illumination guide layer, along with a metal target that deforms enough for a robust button press detection. An alternative to this design is to move the illumination guide between the metal target and sensor coil and have a cutout in the metal target for light to shine through.

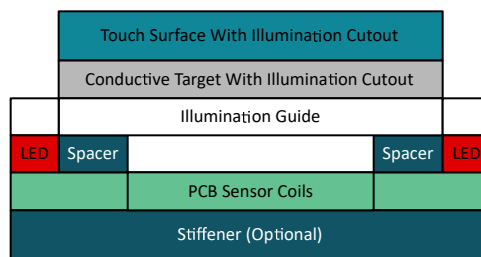

Figure 2-9. Illuminated LDC Touch Button Illumination Guide Alternative

The illumination guide may not be required in this application if the LEDs can be used as spacers instead. This implementation potentially moves the metal target further away from the sensor coil and requires a hole or cutout to be added to the metal target. The shape and size of the hole will have an impact on the target and sensor coupling by disrupting the eddy currents that form on the target. Simulating the eddy currents on a square target from a circular sensor coil yields the following.

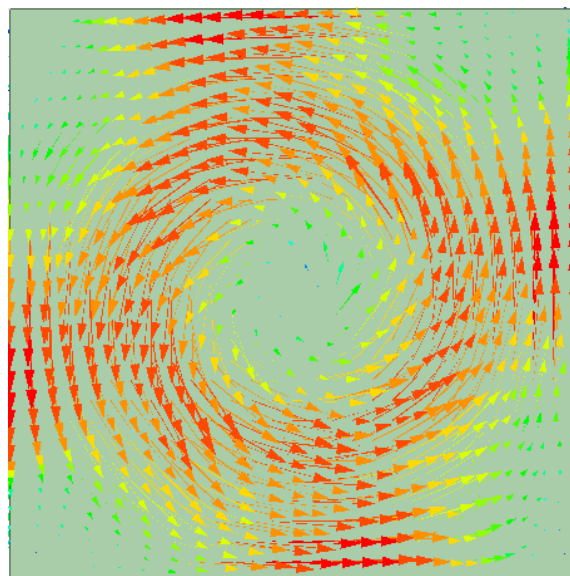

Figure 2-10. Eddy Current Formation

The eddy currents formed on the target are in a circle, therefore a small hole in the center of the metal will not have a large impact on the button performance. The size of the hole is an important factor as a larger hole will decrease the coupling between target and sensor coil.

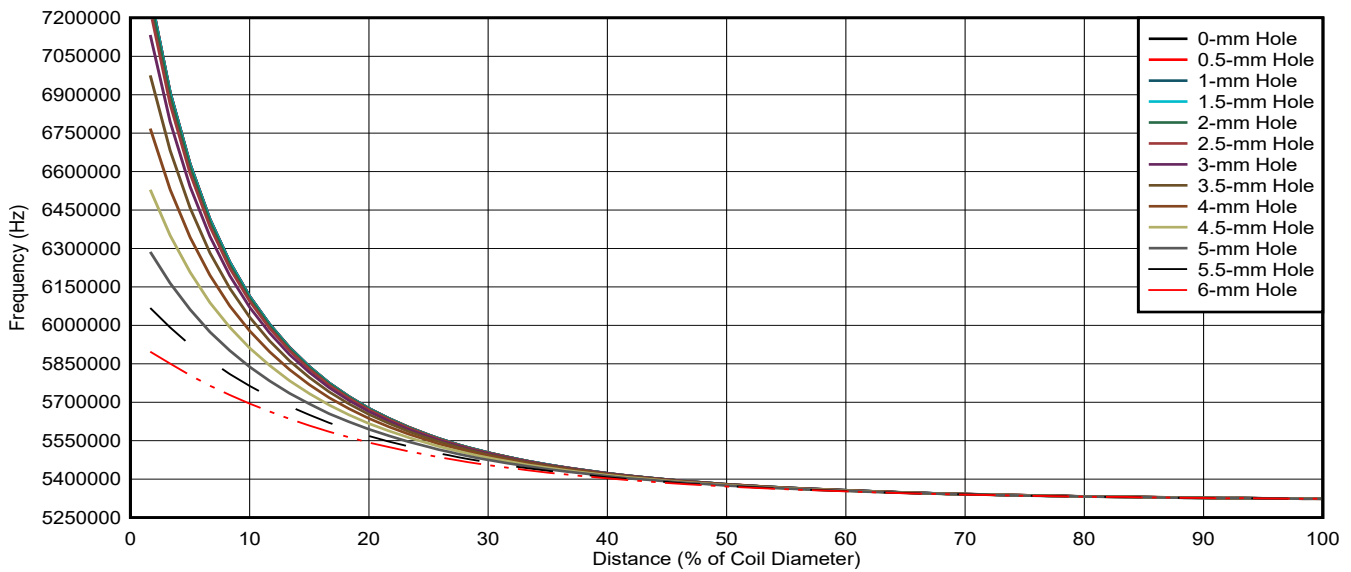

Figure 2-11. Hole Size Comparison

As shown from the graph above, a small hole does not pose a significant change in the sensor frequency when the target is at close ranges, but when the hole becomes larger, the amount of change on the sensor is decreased. Having less frequency change would cause the button to require more motion or more force for a button press to be detected. Additionally, if the button is deforming in the center of the metal target, the impact of a larger hole will be more significant to the target coupling because less metal will deform towards the sensor. Alternatively, the LED can be placed inside the sensor coil rather than on the outside to prevent the need for an illumination guide to disperse the light. An example stackup of this can be seen below.

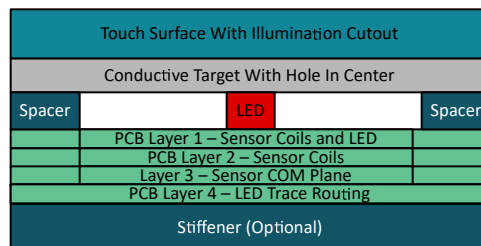

Figure 2-12. Inductive Touch Button With Center LED Stackup

This implementation routes the LED traces down to the fourth layer and away from the sensor coils to keep their impact to a minimum. The metal added from the LED will cause some slight change in the coupling between the sensor and metal target, but not enough to impact button performance when the target is kept close to the sensor coil. The designer can replace the conductive target with a spring to allow mechanical travel if the design requires that function. Using a spring as the target introduces a new set of concerns for the application that designers must consider. First, the spring must be separated from the coils so they are not touching. This can be done by simply expanding the spacer to cover part of the inductive coil. The shape and style of the spring is also an issue. A traditional compression spring may not provide much inductance shift for a button application. To solve this, a spring where the first layer is not in contact with itself until the spring is compressed can be used. The spring would have a gap and would not form a complete circle, therefore eddy currents would not form normally on the spring. As the spring is compressed and creates a complete circle or ring target, the eddy currents will form more similarly to Figure 2-10, and a large inductance shift will occur. Alternatively, if a conical spring is used, the hole in the center of the target will decrease and allow for the inductance to shift as the hole size decreases. The possibilities for implementing an inductive touch button are not limited to just these methods. Using a metal as the target gives freedom in the design to take advantage of an existing mechanical structure as long as the implementation can provide a way for the metal to cause an inductance shift on the sensor coil when the user interacts with the touch surface.

3 Dials, Knobs, and Rotational Selectors

Two applications where dials or knobs are used in automotive applications are volume and air control. These applications can monitor the change in rotational angle or the absolute position of the dial depending on the design preference. There are different ways to achieve these designs, but common implementations include rotary encoders and potentiometers.

3.1 Mechanical Dials

Traditional implementations of mechanical rotary encoders use a metal brush that slides over metal contacts to show the change in rotational motion. These are simple implementations, but are prone to wear and tear as the metal contacts move. Mechanical potentiometers are built in a similar fashion but have a continuous change in resistance from the metal brush moving rather than discrete steps.

3.2 Hall 3D Linear Dial

One way to remove the risk of wear and tear from electro-mechanical wear and tear is to use a sensor that does not have mechanical contacts. Linear Hall-effect sensors can give a variable output for a changing magnetic field. For a rotational sensing application, designers can have a magnet rotating with the dial and sense the two changing axis of the magnetic field.

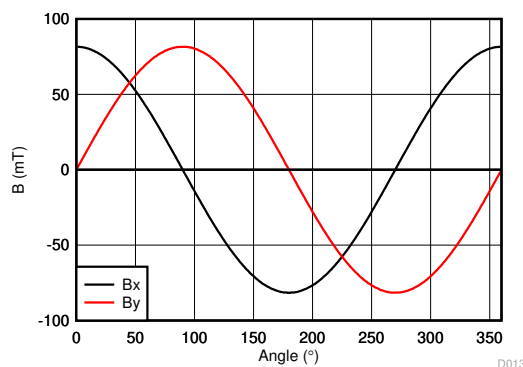

Figure 3-1. Magnetic Field Components For Magnet Rotation

Designers can use a single 3D linear Hall sensor to get these measurements. From the data shown, only the Bx and By fields are required to calculate the angle of the magnet. Devices like the [TMAG5170-Q1](#) and [TMAG5173-Q1](#) can measure all three axis of the magnetic field and even provide the angle of the magnet through a register value so that the microcontroller (MCU) does not have to calculate the angle based on the field data. If the magnet is aligned with the sensor, the two axis of magnetic field data can also be used to implement a push button. The third axis of the magnetic field can be used to provide some predictive failure data or assist in the push button feature for cases where the first two axis cannot provide a reliable push button output. The push button on a rotational dial implementation is showcased in the TMAG5170UEVM's rotate and push module. One downside to this method of sensing is that external magnetic fields can impact the rotational measurement. Sensing the presence of an external field is possible with a 3D sensor or an extra Hall sensor, but the presence of the field can still impact normal functionality. For more information on using Hall-effect sensors in linear dial applications, see the [Absolute Angle Measurements for Rotational Motion Using Hall-Effect Sensors application brief](#).

3.3 Encoder Using Hall

Another Hall implementation for rotational sensing is as an encoder. This method looks at the change in rotation using a transitioning magnetic field polarity over a Hall sensor, typically a Hall-effect latch. These are similar to mechanical rotary encoders in function but remove the electro-mechanical contacts that cause wear and tear. A common way to implement this is to have a ring magnet with multiple poles in the encoder. As the poles move and the magnetic field switches from north to south or vice versa above the magnetic sensor, the output of the switch or latch can be used to show the change in rotational motion. Switches will give an output for both polarities of a magnetic field while latches will change output state when the magnetic field polarity changes. The [TMAG5110](#) is a 2D latch that gives separate outputs for the X and Y components of the magnetic field.

This provides a quadrature output of the magnet rotation that can give the direction of rotation and an increased number of output states compared to a single 1D latch.

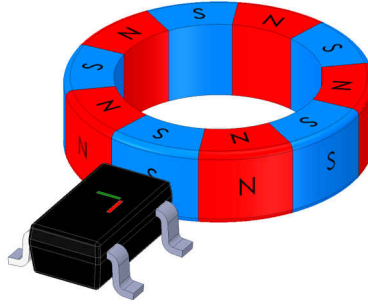

Figure 3-2. In-Plane Sensor

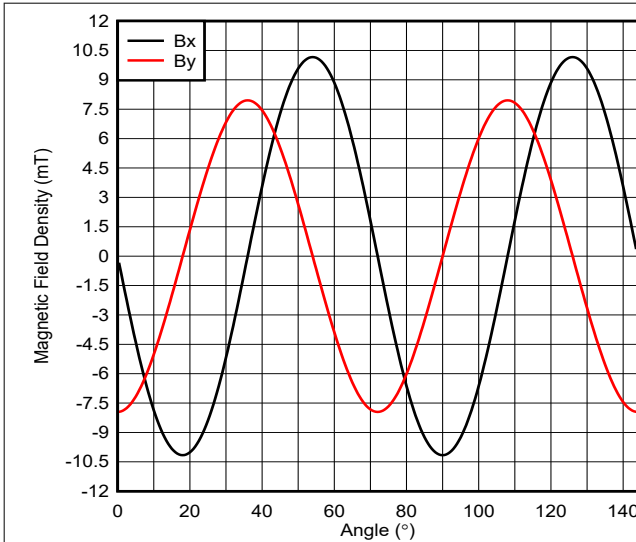

Figure 3-3. Magnetic Field Components

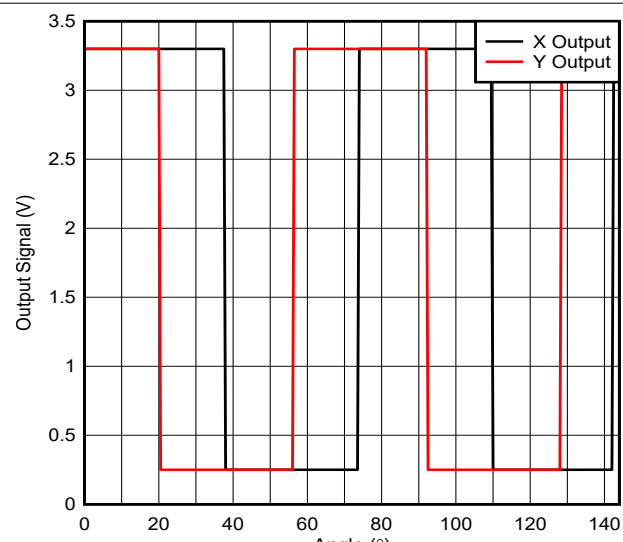

Figure 3-4. TMAG5110 Output

Alternatively, designers can use multiple 1D latches in a Hall-effect encoder to achieve a similar result. Positioning two latches out of phase will give four unique output conditions as each complete magnetic pole pair pass the sensors.

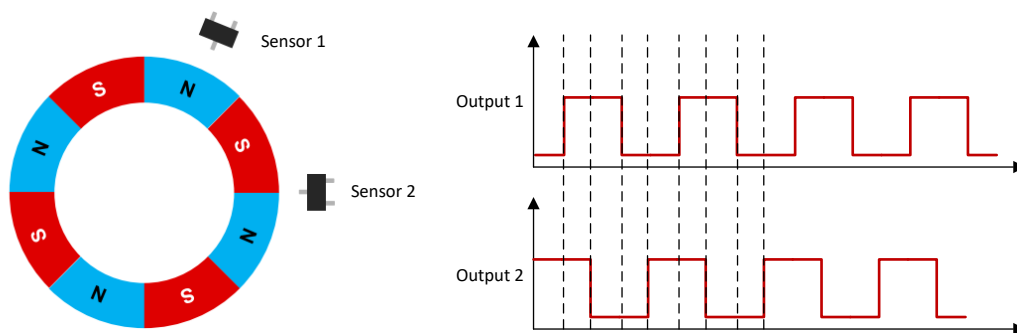

Figure 3-5. Dual Latch Placement and Output

The positions of the Hall sensor and the magnet choice of the design are important to achieve a robust output with the desired number of increments per turn. As previously mentioned, devices like the [TMAG5110](#) and [TMAG5111](#) offer a 2D dual output option to give similar results in only one device package. For more information on implementing a quadrature Hall-effect incremental encoder, see the [Reducing Quadrature Error for Incremental Rotary Encoding Using 2D Hall-Effect application note](#). Hall-effect sensors make encoders easy

to design and easy to scale the number of positions per rotation because the design only requires a ring magnet with the correct number of pole pairs for the design to work. However, similar to Hall switches, this implementation can be subject to interference from external DC magnetic fields.

3.4 Encoder Using Inductive

Inductive based encoders are similar to Hall-effect sensing but they use any conductive metal as the target and are immune to DC magnetic fields. These sensors can often use a metal that is already present in a mechanical design such as the teeth of a rotating gear to give an incremental output. One example of an inductive encoder is the [Inductive Sensing 32-Position Encoder Knob Reference Design using the LDC0851](#). This reference design uses a metal target in a PCB that is attached to the knob. As the metal crosses over the inductive sensing coils, the inductance increases and decreases in a cyclical pattern. The LDC0851 does a comparison between the sensor and reference coils to determine whether the digital output must be high or low.

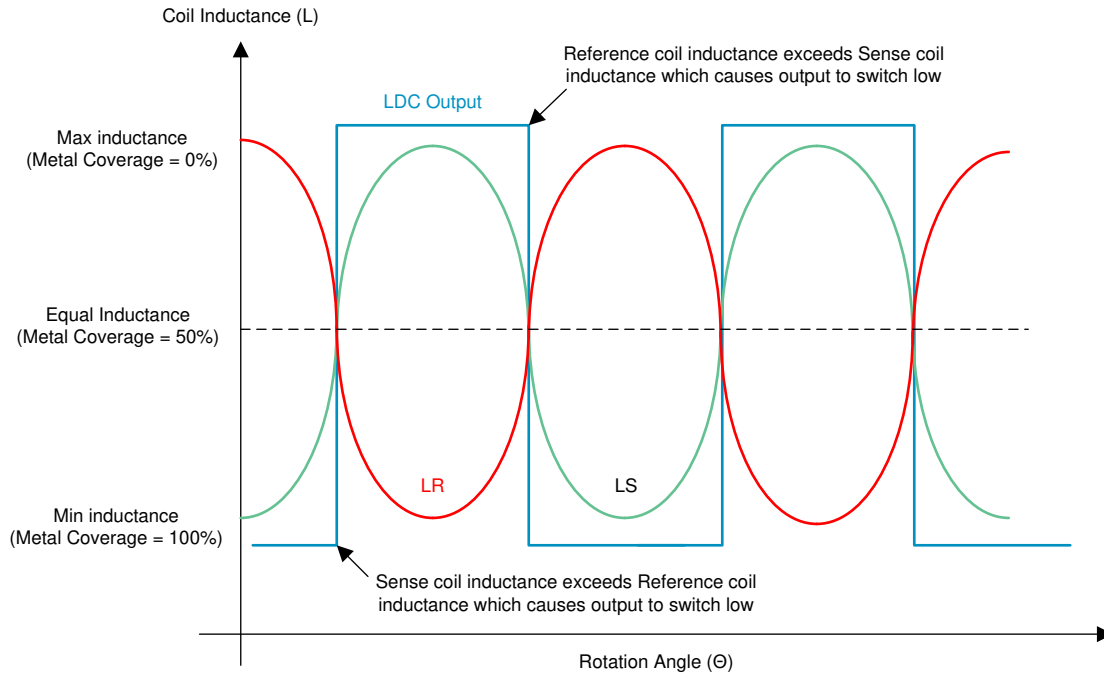

Figure 3-6. LDC0851 Encoder Inductance Change and Digital Output

If the designer places the sensors correctly, the design can achieve a quadrature output and increase the number of positions detected by each passing metal target.

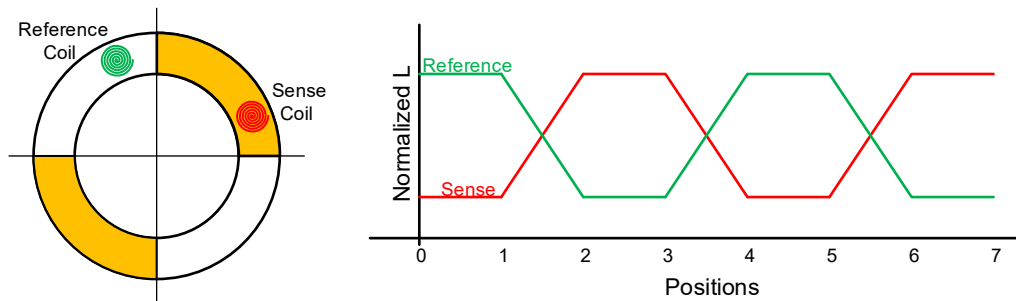

Figure 3-7. Reference Coil Placement and Inductance Shifts

As seen in [Figure 3-7](#), there are eight positions per rotation for a two-target design. Implementing an inductive encoder this way provides a robust solution that is immune to dirt, grease, and external DC magnetic fields but designers must consider the limitations of this approach. The size of the inductive sensor is an important factor to keep in mind. The distance between the metal target and inductive sensor coil is a direct relationship to the coil diameter, therefore the target distance must decrease whenever the coil size decreases. While

implementing small coils is possible, there must be enough space to layout a PCB coil under the metal target. Layout techniques like those used in the [LDC1312 Incremental Encoder Knob reference design guide](#) can be used to implement smaller coils, but it can still be difficult to design a high positions per rotation encoder in a small space.

3.5 Scroll Wheels

Scroll wheels are similar to the encoder and linear rotational sensing methods, but the axis of rotation is changed. A common automotive application is volume control, especially on a steering wheel. Hall-effect sensing allows the designer to place the magnet in a sealed cylinder to act as the user interface while the sensor is just placed on a PCB below the wheel. The same linear and encoder implementations can occur here where a sensor is placed in-plane with the magnet. For the linear case, placing the sensor on axis with the magnet can be more difficult so it is likely the sensor will be in-plane or out-of-plane.

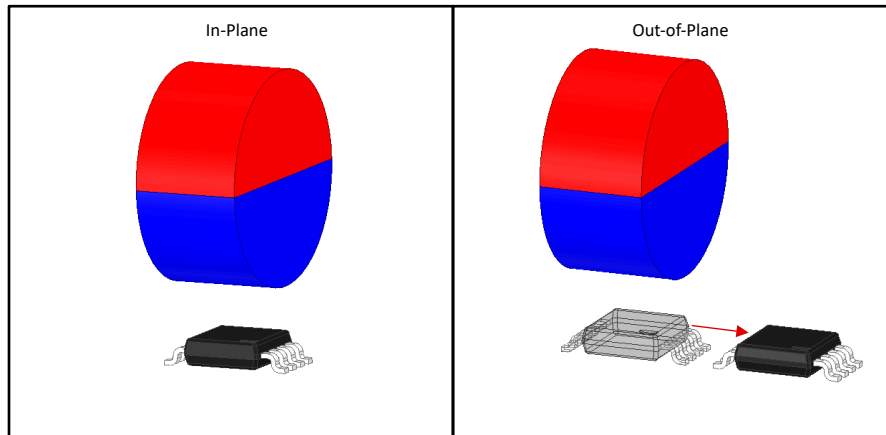

Figure 3-8. Scroll Wheel Magnet With Linear Hall Sensor Placement

The placement of the sensor will impact the magnetic fields seen by the sensor. For the in-plane case, the Z axis of the magnetic field is completely static while the X and Y axis will have different amplitudes. The out-of-plane case can help a designer get a similar amplitude in the sinusoidal change in magnetic field due to the rotating magnet. Achieving a similar amplitude requires careful position of the sensor as there will be an optimal placement where the magnetic field amplitudes for a given magnet. Simulating the magnetic field for different positions along the path of potential sensor placement can help determine the best location for amplitude matching. While the sensor is moved away from being in-plane with the magnet, the Z axis of the magnetic field will also have start to give a sinusoidal signal.

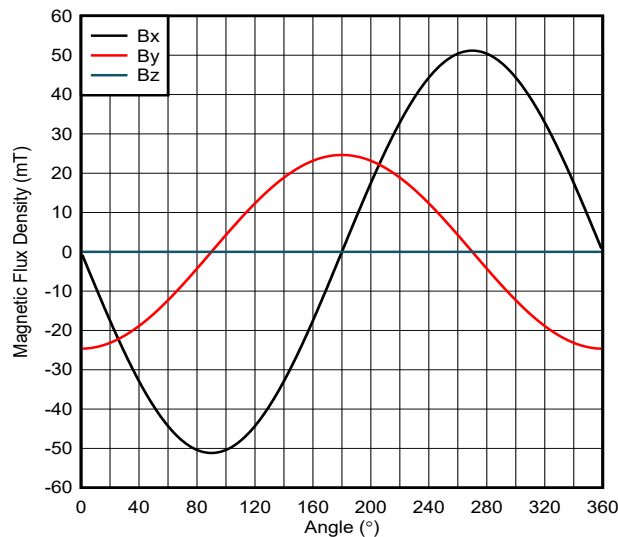

Figure 3-9. Scroll Wheel Sensor Magnetic Fields: In-Plane Sensor

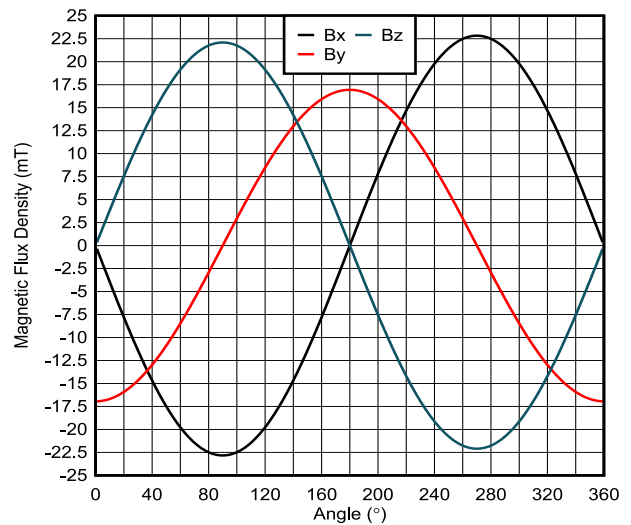

Figure 3-10. Scroll Wheel Sensor Magnetic Fields: Out-of-Plane Sensor

As seen above, the amplitudes of the out-of-phase case are more similar and would require less scaling to amplitude match before calculating the angle of the magnet. Similar to the dial rotation method, using a 3D linear sensor to read the magnetic field data provides enough information to implement a push button.

The incremental case is not any different from the encoder implementation, but the case will likely require the sensors be in-plane or slightly offset from the ring magnet. The digital output from the device will still have the same behavior as long as the magnetic threshold of the sensor and magnet choice align. This could easily be implemented with a [TMAG5110](#) or [TMAG5111](#) to sense the rotational motion.

3.6 Rocker Switches

Rocker switches vary slightly from standard push buttons. These are typically a three-position switch and can either stay in the last pressed position, or spring back to the neutral or middle position. There are many ways to implement this type of switch and three of these are shown in the figure below.

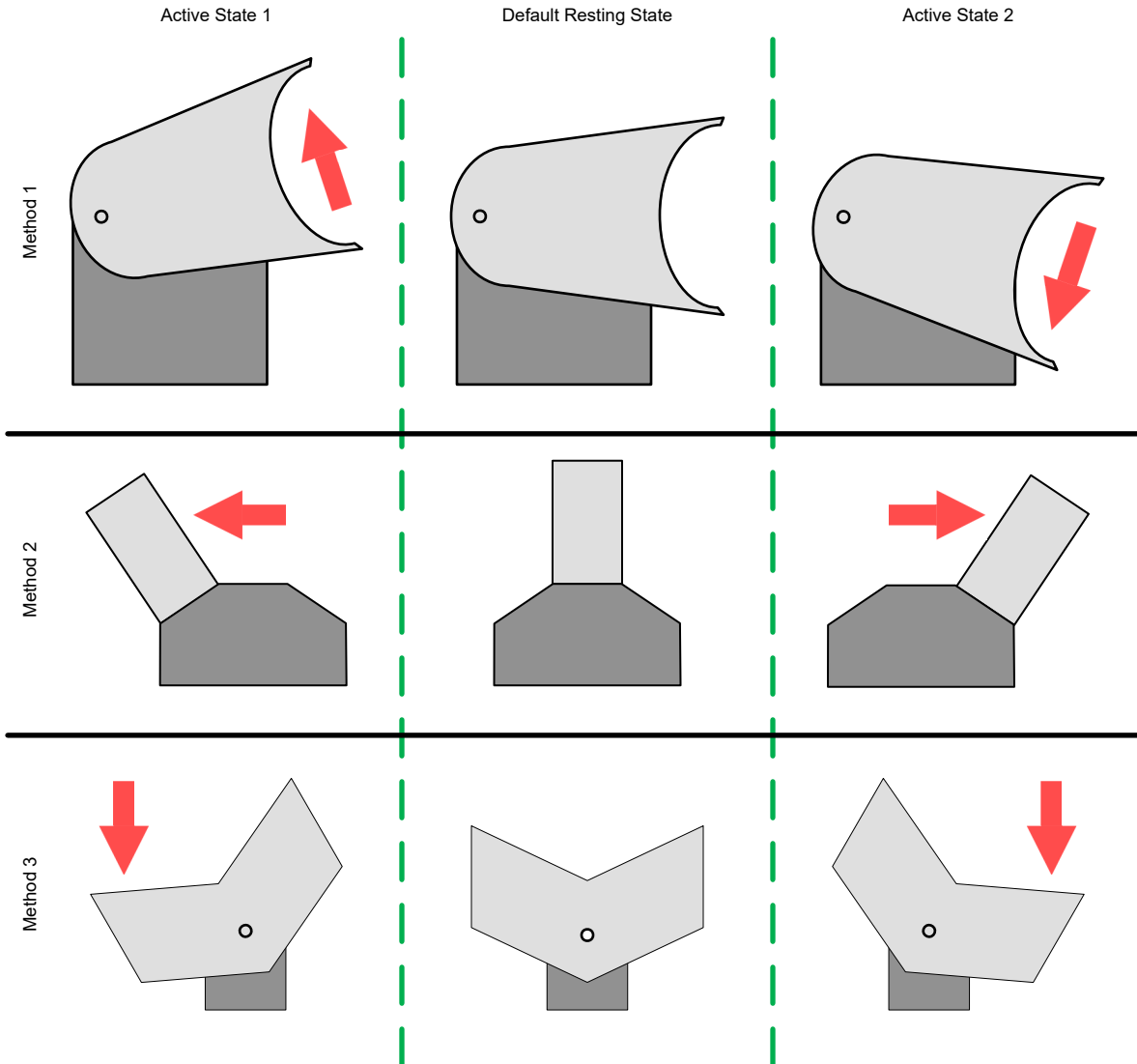

Figure 3-11. Tri-State Switch Implementation Examples

Implementing this type of switch can be done with different technologies. Designers can incorporate this method with electro-mechanical contacts similar to the encoder or button applications. The same problem of wear and tear would apply here as it does in those other applications. Designers can use a magnetic Hall sensing based solution or an inductive sensing based solution for a contactless rocker switch. Designers can implement the Hall-effect sensor solution using either linear, latch, or switch sensors. For more information on how to use Hall to implement these tri-state switches, see the [HMI Rocket Switch With Hall-Effect Switches application note](#). For the inductive sensing application, this would be similar to the touch button or encoder solution. Depending on the mechanical motion of the switch, a metal target could pass over two different sensor coils depending on the state of the switch.

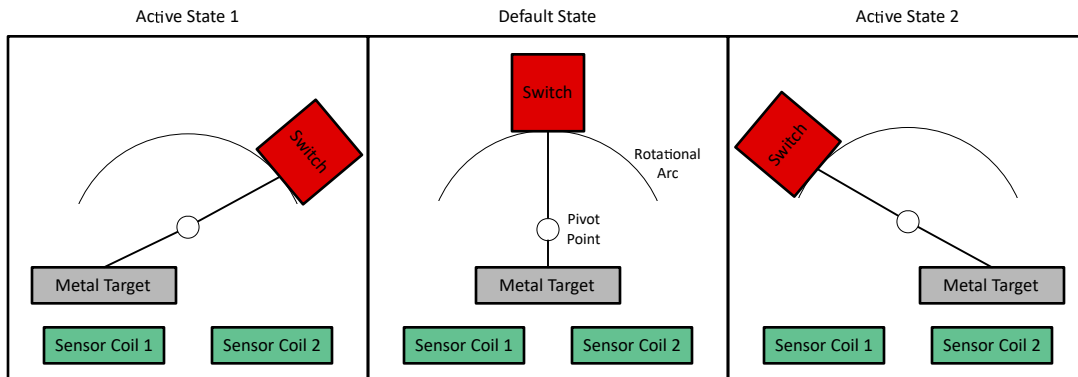

Figure 3-12. Inductive Tri-State Switch Concept

Alternatively, each active state can have their own metal target that moves closer to the inductive sensor coil when that active state is chosen. There is freedom of design to match the mechanical motion required because the only components required are the sensor coils and the metal target.

In comparison of the implementations, the mechanical design is cheap and simple, but the design is more prone to wearing down over time. The Hall based solution is easy to implement and does not have the same wear and tear concerns, but this solution requires a magnet and can be susceptible to external magnets. The inductive sensing implementation also removes the wear and tear concern while being immune to DC magnetic fields, and this option can use any conductive metal as the target. This option does require additional design effort, however, to create the sensor coils.

4 Summary

There are many different applications for HMI in an automotive environment and a variety of technology designers can use to implement them. Each application has its own key factors to consider and every use case for one of these applications can have different requirements. It is important to identify the main concerns of your designs and understand how the HMI application will be used by the end user to pick the best technology. In general, mechanical implementations will be cheap but prone to wear and tear which can lead to a loss of functionality. Hall-effect sensors can provide some design freedom and are easy to incorporate, but they can be susceptible to external magnetic fields. Capacitive sensing is great for seamless touch panels, but require a few extra considerations in specific applications. Inductive sensing can be used in touch sensing and removes some of the concerns with capacitive sensing, but has other drawbacks. Additionally, inductive rotational sensors can provide a solution that are immune to nearby DC magnetic fields and work with existing metals in a solution, but can be limited by space for the sensor coils. Whatever the implementation choice is, there are tools available to assist in the design process. Please refer to the Resources section for a list of helpful tools and support content TI offers.

5 References

5.1 Device Support

- [Inductive Sensing Coil Designer Spreadsheet](#)
- [Inductive Sensing Training Overview Video](#)
- [Magnetic Sensing Proximity Tool](#)
- [TMAG5170 2D Angle Error Calculator](#)

5.2 Related Documentation

- Texas Instruments, [Capacitive Touch Through Metal Using MSP430 MCUs with CapTIvate Technology application note](#)
- Texas Instruments, [Reducing Quadrature Error for Incremental Rotary Encoding Using 2D Hall-Effect application note](#)
- Texas Instruments, [Absolute Angle Measurements for Rotational Motion Using Hall-Effect Sensors application brief](#)
- Texas Instruments, [Inductive Sensing Device Selection Guide](#)
- Texas Instruments, [Sensor Design for Inductive Sensing Applications Using LDC application note](#)
- Texas Instruments, [TMAG5170EVM user's guide](#)
- Texas Instruments, [LDC1312 Incremental Encoder Knob reference design guide](#)
- Texas Instruments, [HMI Rocket Switch With Hall-Effect Switches application note](#)

IMPORTANT NOTICE AND DISCLAIMER

TI PROVIDES TECHNICAL AND RELIABILITY DATA (INCLUDING DATA SHEETS), DESIGN RESOURCES (INCLUDING REFERENCE DESIGNS), APPLICATION OR OTHER DESIGN ADVICE, WEB TOOLS, SAFETY INFORMATION, AND OTHER RESOURCES "AS IS" AND WITH ALL FAULTS, AND DISCLAIMS ALL WARRANTIES, EXPRESS AND IMPLIED, INCLUDING WITHOUT LIMITATION ANY IMPLIED WARRANTIES OF MERCHANTABILITY, FITNESS FOR A PARTICULAR PURPOSE OR NON-INFRINGEMENT OF THIRD PARTY INTELLECTUAL PROPERTY RIGHTS.

These resources are intended for skilled developers designing with TI products. You are solely responsible for (1) selecting the appropriate TI products for your application, (2) designing, validating and testing your application, and (3) ensuring your application meets applicable standards, and any other safety, security, regulatory or other requirements.

These resources are subject to change without notice. TI grants you permission to use these resources only for development of an application that uses the TI products described in the resource. Other reproduction and display of these resources is prohibited. No license is granted to any other TI intellectual property right or to any third party intellectual property right. TI disclaims responsibility for, and you will fully indemnify TI and its representatives against, any claims, damages, costs, losses, and liabilities arising out of your use of these resources.

TI's products are provided subject to [TI's Terms of Sale](#) or other applicable terms available either on [ti.com](https://www.ti.com) or provided in conjunction with such TI products. TI's provision of these resources does not expand or otherwise alter TI's applicable warranties or warranty disclaimers for TI products.

TI objects to and rejects any additional or different terms you may have proposed.

Mailing Address: Texas Instruments, Post Office Box 655303, Dallas, Texas 75265
Copyright © 2023, Texas Instruments Incorporated