



# Typical TVS Applications

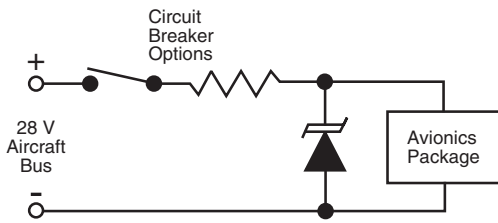

Fig. 1 - 28 V<sub>DC</sub> Supply Protection

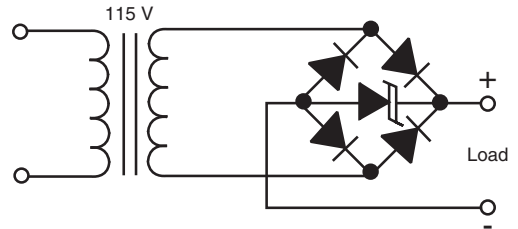

Fig. 5 - 115 V<sub>AC</sub> Supply Protection

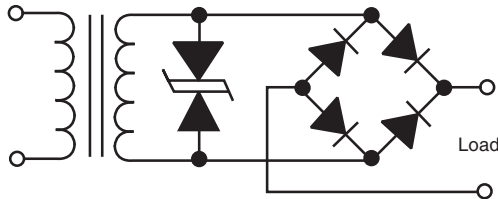

Fig. 2 - AC Supply Protection

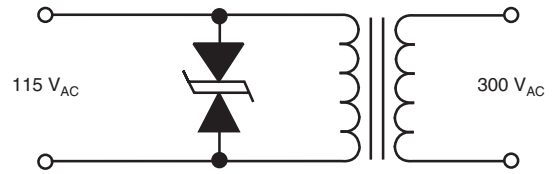

Fig. 6 - Circuit Protection from Overvoltage Supply

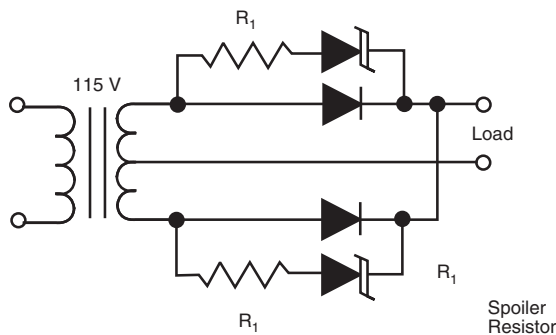

Fig. 3 - Breakdown Voltage Rectifier Protection

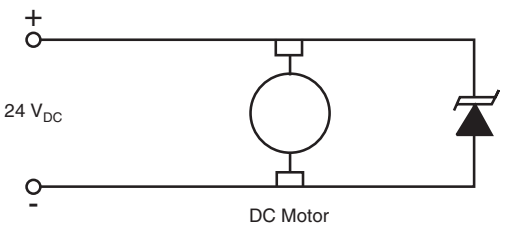

Fig. 7 - EMI Limiting

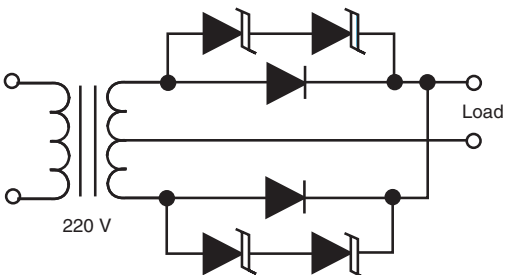

Fig. 4 - Breakdown Voltage Rectifier Protection

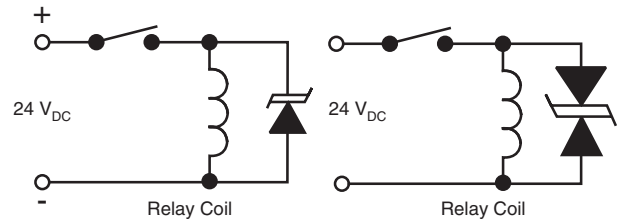

Fig. 8 - Relay and Contractor Transient Limiting

APPLICATION NOTE

### Typical TVS Applications

