

●Structure

Silicon N-channel MOSFET

●Features

- 1) Built-in G-S Protection Diode.
- 2) Small Surface Mount Package (TUMT3).
- 3) Low voltage drive. (4V)

●Application

Switching

●Packaging specifications

Type	Package	Taping
	Code	TL
	Quantity (pcs)	3000
RSF015N06FRA		○

●Absolute maximum ratings (Ta = 25°C)

Parameter	Symbol	Limits	Unit
Drain-source voltage	V_{DSS}	60	V
Gate-source voltage	V_{GSS} *1	±20	V
Drain current	Continuous	I_D	±1.5 A
	Pulsed	I_{DP} *1	±6.0 A
Source current (Body Diode)	Continuous	I_S	0.6 A
	Pulsed	I_{SP} *1	6.0 A
Power dissipation	P_D *2	0.8	W
Channel temperature	T_{ch}	150	°C
Range of storage temperature	T_{stg}	-55 to +150	°C

*1 $P_w \leq 10\mu s$, Duty cycle $\leq 1\%$

*2 Mounted on a ceramic board.

●Thermal resistance

Parameter	Symbol	Limits	Unit
Channel to Ambient	$R_{th}(ch-a)^*$	156	°C / W

*Mounted on a ceramic board.

●Dimensions (Unit : mm)

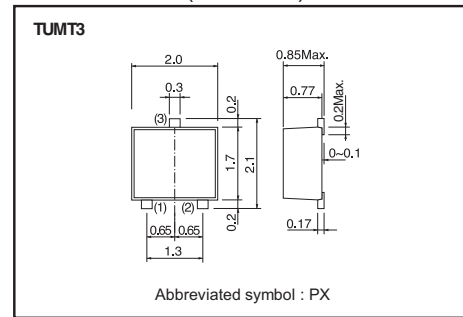

●Inner circuit

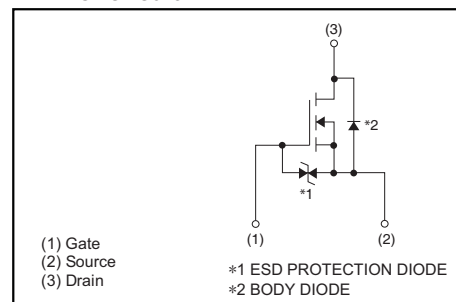

●Electrical characteristics (Ta = 25°C)

Parameter	Symbol	Min.	Typ.	Max.	Unit	Conditions
Gate-source leakage	I_{GSS}	-	-	±10	μA	$V_{GS}=\pm 20V, V_{DS}=0V$
Drain-source breakdown voltage	$V_{(BR)DSS}$	60	-	-	V	$I_D=1mA, V_{GS}=0V$
Zero gate voltage drain current	I_{DSS}	-	-	1	μA	$V_{DS}=60V, V_{GS}=0V$
Gate threshold voltage	$V_{GS(th)}$	1.0	-	2.5	V	$V_{DS}=10V, I_D=1mA$
Static drain-source on-state resistance	$R_{DS(on)}^*$	-	210	290	mΩ	$I_D=1.5A, V_{GS}=10V$
		-	240	330		$I_D=1.5A, V_{GS}=4.5V$
		-	255	350		$I_D=1.5A, V_{GS}=4.0V$
Forward transfer admittance	$ Y_{fs} ^*$	1.0	-	-	S	$I_D=1.5A, V_{DS}=10V$
Input capacitance	C_{ISS}	-	110	-	pF	$V_{DS}=10V$
Output capacitance	C_{OSS}	-	28	-	pF	$V_{GS}=0V$
Reverse transfer capacitance	C_{RSS}	-	12	-	pF	$f=1MHz$
Turn-on delay time	$t_{d(on)}^*$	-	6	-	ns	$I_D=0.7A, V_{DD}=30V$
Rise time	t_r^*	-	9	-	ns	$V_{GS}=10V$
Turn-off delay time	$t_{d(off)}^*$	-	15	-	ns	$R_L=42.8\Omega$
Fall time	t_f^*	-	10	-	ns	$R_G=10\Omega$
Total gate charge	Q_g^*	-	2.0	-	nC	$I_D=1.5A$
Gate-source charge	Q_{gs}^*	-	0.8	-	nC	$V_{DD}=30V$
Gate-drain charge	Q_{gd}^*	-	0.5	-	nC	$V_{GS}=5V$

*Pulsed

●Body diode characteristics (Source-Drain) (Ta = 25°C)

Parameter	Symbol	Min.	Typ.	Max.	Unit	Conditions
Forward Voltage	V_{SD}^*	-	-	1.2	V	$I_S=1.5A, V_{GS}=0V$

*Pulsed

●Electrical characteristic curves (Ta=25°C)

Fig.1 Typical Output Characteristics(I)

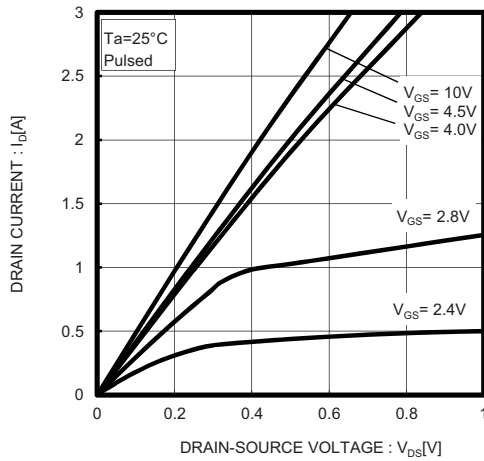

Fig.2 Typical Output Characteristics(II)

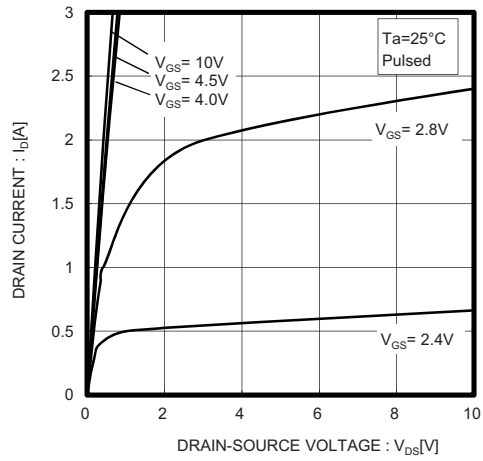

Fig.3 Typical Transfer Characteristics

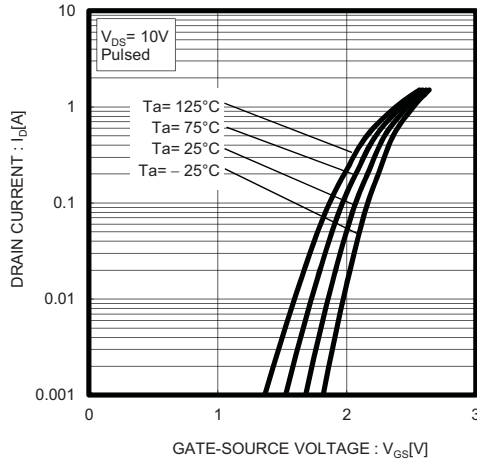

Fig.4 Static Drain-Source On-State Resistance vs. Drain Current(I)

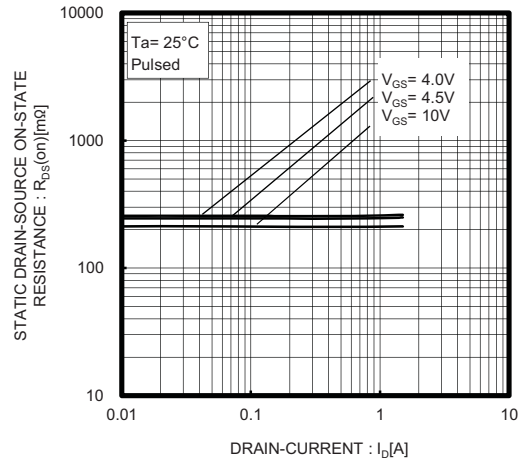

Fig.5 Static Drain-Source On-State Resistance vs. Drain Current(II)

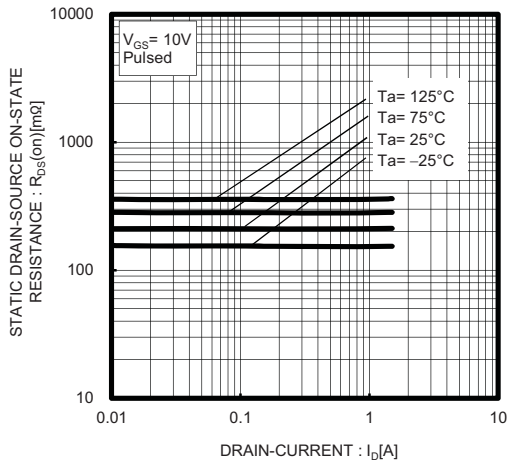

Fig.6 Static Drain-Source On-State Resistance vs. Drain Current(III)

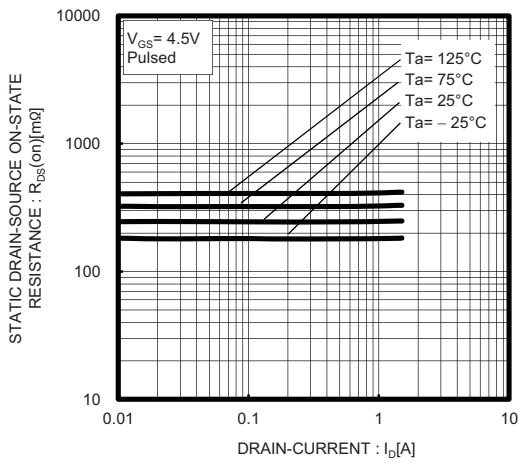

Fig.7 Static Drain-Source On-State Resistance vs. Drain Current(I_D)

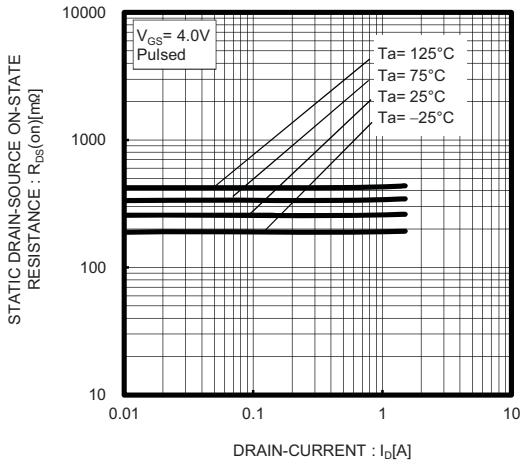

Fig.8 Forward Transfer Admittance vs. Drain Current

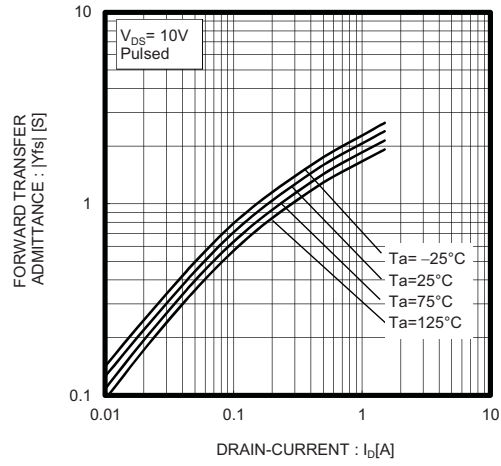

Fig.9 Source Current vs. Source-Drain Voltage

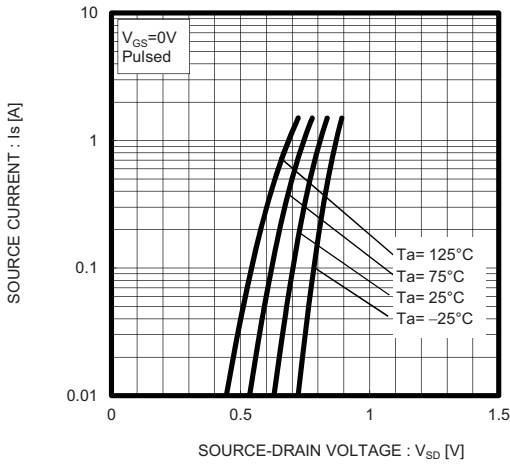

Fig.10 Static Drain-Source On-State Resistance vs. Gate Source Voltage

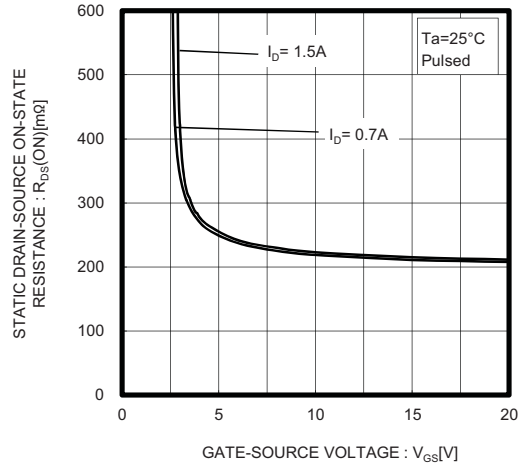

Fig.11 Switching Characteristics

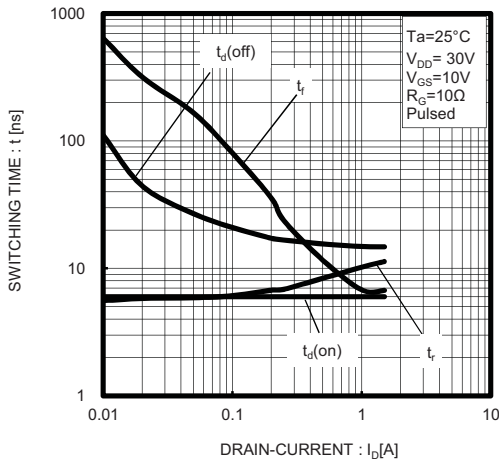

Fig.12 Dynamic Input Characteristics

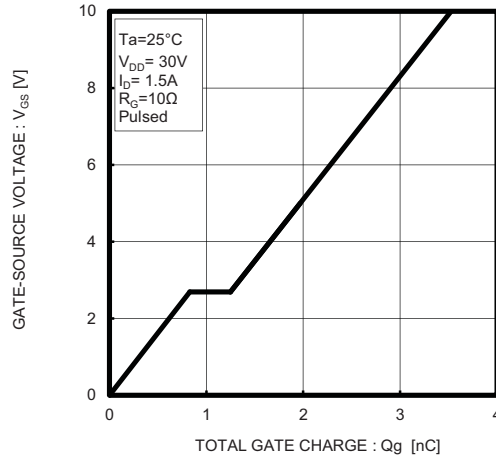
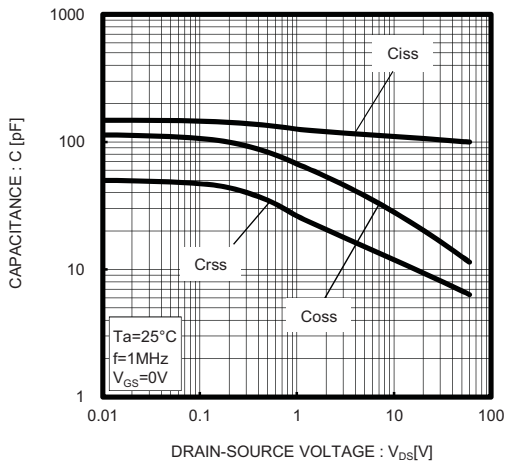

Fig.13 Typical Capacitance vs. Drain-Source Voltage



● Measurement circuits

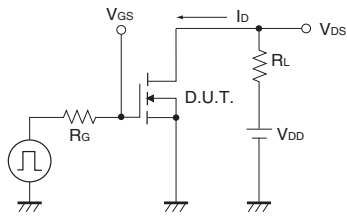

Fig.1-1 Switching Time Measurement Circuit

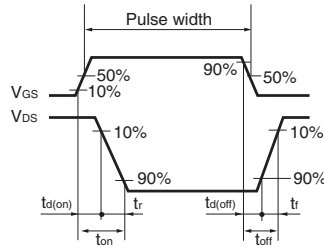

Fig.1-2 Switching Waveforms

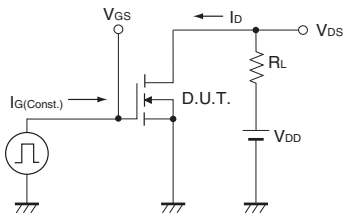

Fig.2-1 Gate Charge Measurement Circuit

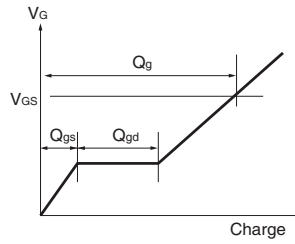

Fig.2-2 Gate Charge Waveform