

## Evaluating the **ADP196** High-Side Load Switch

### FEATURES

**Low  $R_{DS(on)}$ : 27 m $\Omega$  (LFCSP)**

**Wide input voltage range: 1.8 V to 5.5 V**

**Quick output discharge (QOD) circuit option**  
([ADP196ACPZN-01-R7](#))

**3 A continuous operating current to 70°C**

**Tiny, 2.0 mm  $\times$  2.0 mm  $\times$  0.55 mm, 0.65 mm pitch, 6-lead LFCSP**

**Operating temperature range:  $T_J = -40^\circ\text{C}$  to  $+85^\circ\text{C}$**

### GENERAL DESCRIPTION

The **ADP196** evaluation board, [ADP196CP-EVALZ](#), is used to demonstrate the functionality of the **ADP196** high-side load switch.

Simple device measurements such as  $V_{IN}$  to  $V_{OUT}$  resistance ( $R_{DS(on)}$ ), ground current, and off-state current can be demonstrated with only a single voltage source, a voltage meter, a current meter, and a load resistor.

Complete information about the **ADP196** high-side load switch is available in the **ADP196** data sheet, which should be consulted when using the [ADP196CP-EVALZ](#).

### LAYOUT OF EVALUATION BOARD

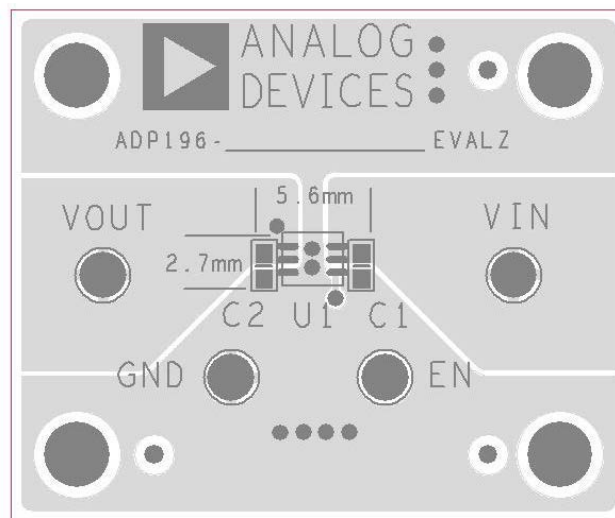

Figure 1. Evaluation Board Layout

## TABLE OF CONTENTS

|   |   |   |   |
|---|---|---|---|
| Features .....                                | 1 | $V_{IN}$ to $V_{OUT}$ Resistance ( $R_{DS(ON)}$ ) Measurements..... | 4 |
| General Description .....                     | 1 | Ground Current Measurements .....                                   | 5 |
| Layout of Evaluation Board.....               | 1 | Ground Current Consumption .....                                    | 5 |
| Revision History .....                        | 2 | Shutdown Current Measurements .....                                 | 6 |
| Evaluation Board Schematic and Hardware ..... | 3 | Bill of Materials.....  | 7 |

## REVISION HISTORY

4/13—Revision 0: Initial Version

## EVALUATION BOARD SCHEMATIC AND HARDWARE

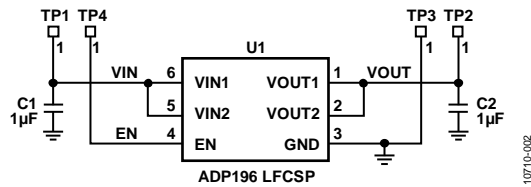

Figure 2. Evaluation Board Schematic

Table 1. LFCSP Evaluation Board Hardware Components

| Component | Function         | Description   |
|-----------|------------------|---|
| U1        | Load switch      | <a href="#">ADP196ACPZN-R7</a> high-side load switch.   |
| C1        | Input capacitor  | Optional input bypass capacitor, 1 µF. Used to improve transient performance. Connect C1 from VIN to GND. |
| C2        | Output capacitor | Optional output capacitor, 1 µF. Used to improve transient performance. Connect C2 from VOUT to GND.      |

## V<sub>IN</sub> TO V<sub>OUT</sub> RESISTANCE (R<sub>DS(ON)</sub>) MEASUREMENTS

R<sub>DS(ON)</sub> is defined as the input-to-output voltage differential divided by load current. The voltage meter (voltmeter) reading divided by the load current value gives the equivalent R<sub>DS(ON)</sub> value.

R<sub>DS(ON)</sub> can be measured using the configuration shown in Figure 4. For more accurate measurements, a second voltmeter can be used to monitor the input voltage across the input capacitor. The input supply voltage may need to be adjusted to account for IR drops, especially if large load currents are used. Figure 3 shows a typical curve of R<sub>DS(ON)</sub> measurements with different load currents.

Follow these steps to connect the evaluation board to a voltage source and voltmeter for R<sub>DS(ON)</sub> measurements:

1. Connect the negative terminal (-) of the voltage source to the GND pad on the evaluation board.
2. Connect the positive terminal (+) of the voltage source to the VIN pad on the evaluation board.
3. Connect a load between the VOUT pad and the GND pad on the evaluation board.
4. Connect the negative terminal (-) of the voltmeter to the VOUT pad on the evaluation board.
5. Connect the positive terminal (+) of the voltmeter to the VIN pad on the evaluation board.

The voltage source can now be turned on. If EN is connected to V<sub>IN</sub> for automatic startup, the switch powers up.

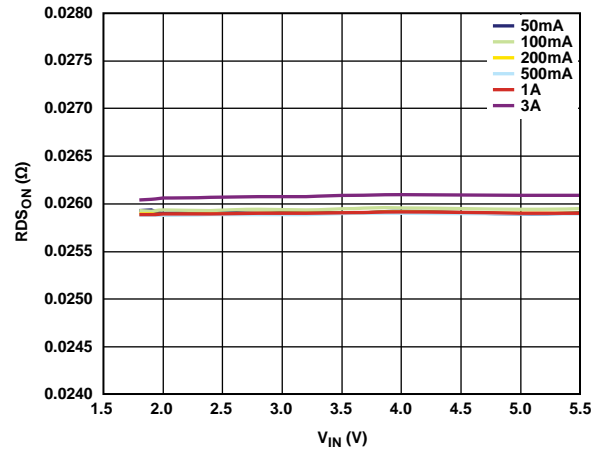

Figure 3. R<sub>DS(ON)</sub> vs. Input Voltage, V<sub>IN</sub>

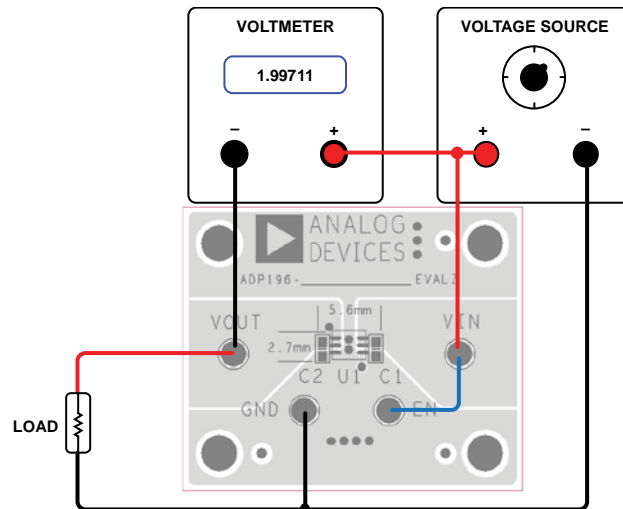

Figure 4. R<sub>DS(ON)</sub> Measurement Configuration

## GROUND CURRENT MEASUREMENTS

Figure 6 show how the evaluation board can be connected to a voltage source and a current meter (ammeter) for ground current measurements. A resistor can be used as the load for the switch. Ensure that the resistor has a power rating adequate to handle the power expected to be dissipated across it. An electronic load can be used as an alternative.

Ensure that the voltage source used can supply enough current for the expected load levels. If a voltmeter is connected at the input or output terminal, subtract the current resulting from the shunt resistance of the voltmeter for accurate ground current measurement.

Follow these steps to connect the evaluation board to a voltage source and ammeter for ground current measurements:

1. Connect the positive terminal (+) of the voltage source to the VIN pad on the evaluation board.
2. Connect the positive terminal (+) of the ammeter to the GND pad on the evaluation board.
3. Connect the negative terminal (-) of the ammeter to the negative (-) terminal of the voltage source.
4. Connect a load between the VOUT pad on the evaluation board and the negative (-) terminal of the voltage source.

The voltage source can now be turned on. If EN is connected to VIN for automatic startup, the switch powers up.

## GROUND CURRENT CONSUMPTION

Ground current measurements can determine how much current the internal circuits of the switch consume while the circuits perform the load switch function. To be efficient, the load switch must consume as little current as possible. Figure 5 shows the typical ground current consumption for various load levels.

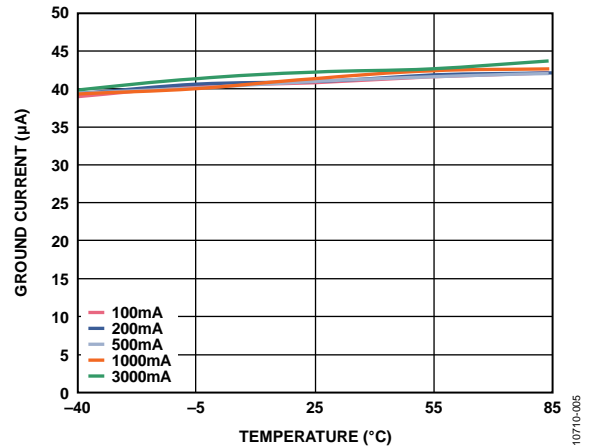

Figure 5. Ground Current vs. Temperature

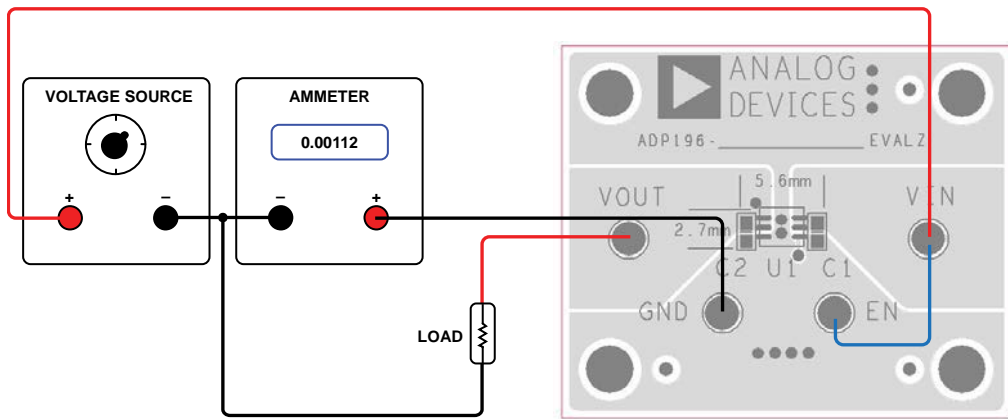

Figure 6. Ground Current Measurement Configuration

## SHUTDOWN CURRENT MEASUREMENTS

Figure 8 show how the evaluation board can be connected to a voltage source and an ammeter for shutdown current measurements. The ammeter can also be connected to the VIN pad to measure the ground current, which is equal to the shutdown current when EN is tied to ground (or left open). Figure 7 shows the typical shutdown current consumption for various input voltages.

Follow these steps to connect the evaluation board to a voltage source and ammeter for shutdown current measurements:

1. Connect the positive terminal (+) of the voltage source to the positive terminal (+) of the ammeter.
2. Connect the negative terminal (-) of the voltage source to the GND pad and the EN pad, or leave the EN pad floating to disable the part.
3. Connect the negative terminal (-) of the ammeter to the VIN pad on the evaluation board.

The voltage source can now be turned on.

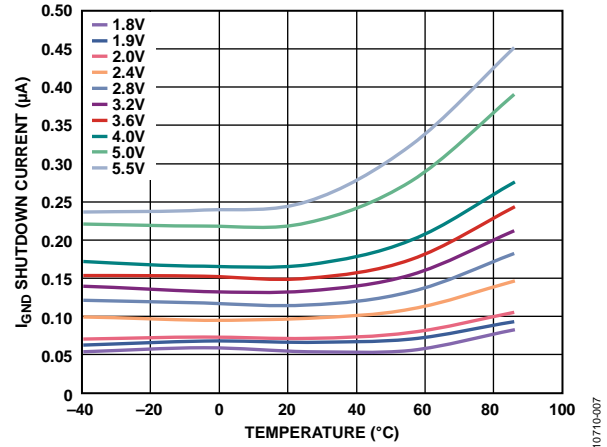

Figure 7. Shutdown Current vs. Temperature and Input Voltage ( $V_{IN}$ )

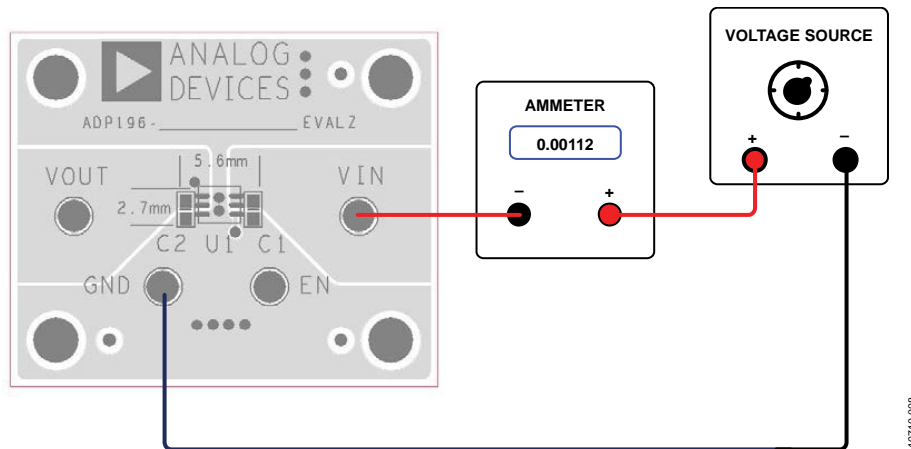

Figure 8. Shutdown Current Measurement Configuration

## BILL OF MATERIALS

Table 2. Bill of Materials

| Qty | Reference Designator | Description                                 | Manufacturer/Vendor  | Part No.                       |
|-----|----------------------|---|----------------------|--------------------------------|
| 2   | C1, C2               | Capacitor, MLCC, 1 $\mu$ F, 10 V, 0402, X5R | Murata or equivalent | GRM155R61A105KA01D             |
| 1   | J2                   | Header, single, STR, two pins               | Digi-Key Corp.       | S1012E-02-ND                   |
| 1   | U1                   | IC, load switch                             | Analog Devices, Inc. | <a href="#">ADP196ACPZN-R7</a> |

## NOTES

**ESD Caution**

**ESD (electrostatic discharge) sensitive device.** Charged devices and circuit boards can discharge without detection. Although this product features patented or proprietary protection circuitry, damage may occur on devices subjected to high energy ESD. Therefore, proper ESD precautions should be taken to avoid performance degradation or loss of functionality.

**Legal Terms and Conditions**

By using the evaluation board discussed herein (together with any tools, components documentation or support materials, the "Evaluation Board"), you are agreeing to be bound by the terms and conditions set forth below ("Agreement") unless you have purchased the Evaluation Board, in which case the Analog Devices Standard Terms and Conditions of Sale shall govern. Do not use the Evaluation Board until you have read and agreed to the Agreement. Your use of the Evaluation Board shall signify your acceptance of the Agreement. This Agreement is made by and between you ("Customer") and Analog Devices, Inc. ("ADI"), with its principal place of business at One Technology Way, Norwood, MA 02062, USA. Subject to the terms and conditions of the Agreement, ADI hereby grants to Customer a free, limited, personal, temporary, non-exclusive, non-sublicensable, non-transferable license to use the Evaluation Board FOR EVALUATION PURPOSES ONLY. Customer understands and agrees that the Evaluation Board is provided for the sole and exclusive purpose referenced above, and agrees not to use the Evaluation Board for any other purpose. Furthermore, the license granted is expressly made subject to the following additional limitations: Customer shall not (i) rent, lease, display, sell, transfer, assign, sublicense, or distribute the Evaluation Board; and (ii) permit any Third Party to access the Evaluation Board. As used herein, the term "Third Party" includes any entity other than ADI, Customer, their employees, affiliates and in-house consultants. The Evaluation Board is NOT sold to Customer; all rights not expressly granted herein, including ownership of the Evaluation Board, are reserved by ADI. CONFIDENTIALITY. This Agreement and the Evaluation Board shall all be considered the confidential and proprietary information of ADI. Customer may not disclose or transfer any portion of the Evaluation Board to any other party for any reason. Upon discontinuation of use of the Evaluation Board or termination of this Agreement, Customer agrees to promptly return the Evaluation Board to ADI. ADDITIONAL RESTRICTIONS. Customer may not disassemble, decompile or reverse engineer chips on the Evaluation Board. Customer shall inform ADI of any occurred damages or any modifications or alterations it makes to the Evaluation Board, including but not limited to soldering or any other activity that affects the material content of the Evaluation Board. Modifications to the Evaluation Board must comply with applicable law, including but not limited to the RoHS Directive. TERMINATION. ADI may terminate this Agreement at any time upon giving written notice to Customer. Customer agrees to return to ADI the Evaluation Board at that time. LIMITATION OF LIABILITY. THE EVALUATION BOARD PROVIDED HEREUNDER IS PROVIDED "AS IS" AND ADI MAKES NO WARRANTIES OR REPRESENTATIONS OF ANY KIND WITH RESPECT TO IT. ADI SPECIFICALLY DISCLAIMS ANY REPRESENTATIONS, ENDORSEMENTS, GUARANTEES, OR WARRANTIES, EXPRESS OR IMPLIED, RELATED TO THE EVALUATION BOARD INCLUDING, BUT NOT LIMITED TO, THE IMPLIED WARRANTY OF MERCHANTABILITY, TITLE, FITNESS FOR A PARTICULAR PURPOSE OR NON-INFRINGEMENT OF INTELLECTUAL PROPERTY RIGHTS. IN NO EVENT WILL ADI AND ITS LICENSORS BE LIABLE FOR ANY INCIDENTAL, SPECIAL, INDIRECT, OR CONSEQUENTIAL DAMAGES RESULTING FROM CUSTOMER'S POSSESSION OR USE OF THE EVALUATION BOARD, INCLUDING BUT NOT LIMITED TO LOST PROFITS, DELAY COSTS, LABOR COSTS OR LOSS OF GOODWILL. ADI'S TOTAL LIABILITY FROM ANY AND ALL CAUSES SHALL BE LIMITED TO THE AMOUNT OF ONE HUNDRED US DOLLARS (\$100.00). EXPORT. Customer agrees that it will not directly or indirectly export the Evaluation Board to another country, and that it will comply with all applicable United States federal laws and regulations relating to exports. GOVERNING LAW. This Agreement shall be governed by and construed in accordance with the substantive laws of the Commonwealth of Massachusetts (excluding conflict of law rules). Any legal action regarding this Agreement will be heard in the state or federal courts having jurisdiction in Suffolk County, Massachusetts, and Customer hereby submits to the personal jurisdiction and venue of such courts. The United Nations Convention on Contracts for the International Sale of Goods shall not apply to this Agreement and is expressly disclaimed.